

RACCORDI A CALZAMENTO

INOX AISI 316L

PLUS

**OTTIMO SISTEMA DI SERRAGGIO CON
IL DADO DI CHIUSURA**

**ADATTO AL CONTATTO CON
ACQUA POTABILE**

**FACILE DA USARE ED
ESTREMAMENTE FORTE**

**COMPLETAMENTE IN ACCIAIO INOX
AISI 316L**





p. 219 / **2700**



p. 219 / **2710**



p. 220 / **2720**



p. 220 / **2725**



p. 220 / **2730**



p. 220 / **2740**



p. 221 / **2745**



p. 221 / **2750**



p. 221 / **2760**



p. 221 / **2770**



p. 222 / **2780**



p. 222 / **2790**



p. 222 / **2612**



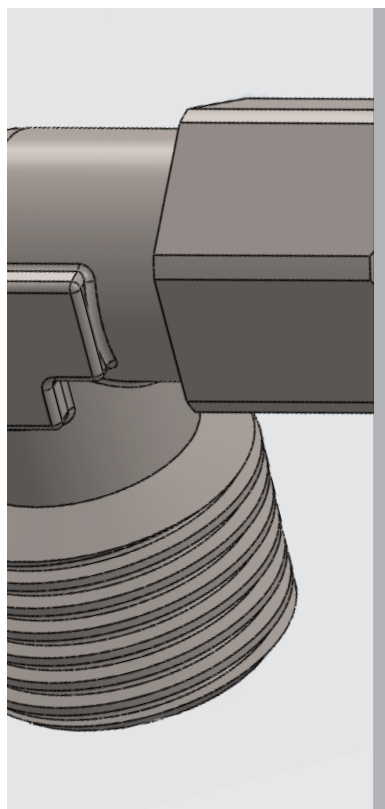

-40°C ÷ +140°C
0°C ÷ +140°C for swivel fittings



Fino a 25 Bar a 20°C.
Fino a 16 Bar a 20°C per raccordi girevoli



Aria compressa, acqua potabile e fluidi alimentari compatibili con i materiali costruttivi



Conica gas BSPT ISO 7 da R1/8" a R1/2"
Cilindrica gas BSPP ISO 228 da G1/8" a G1/2"



Polietilene, PTFE, FEP



Corpo: acciaio inox AISI 316L
Dado: acciaio inox AISI 316L
O-Ring per i raccordi girevoli: Viton

CARATTERISTICHE

I raccordi di questa serie, in quanto completamente in acciaio inox AISI 316L, sono compatibili con alimenti e possono venire a contatto con fluidi aggressivi.



Prodotti conformi alla direttiva 2002/95/EC



Prodotti conformi alla direttiva 2011/65/EU



2700

Diritto maschio cilindrico BSPP

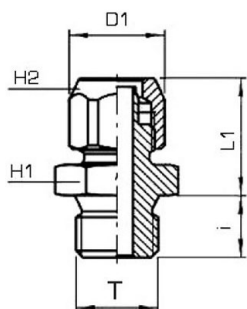

CODE	T	ØD	I	L1	D1	H1	H2	GR.
2700TR1864	G1/8"	6/4	8	18,5	13,0	13	12	15,0
2700TR1464	G1/4"	6/4	10	19,0	13,0	17	12	24,0
2700TR1886	G1/8"	8/6	8	18,5	15,5	13	14	18,0
2700TR1486	G1/4"	8/6	10	19,0	15,5	17	14	27,0
2700TR18108	G1/8"	10/8	8	20,0	18,5	14	17	28,0
2700TR14108	G1/4"	10/8	10	20,5	18,5	17	17	32,0
2700TR38108	G3/8"	10/8	10	20,5	18,5	19	17	40,0
2700TR381210	G3/8"	12/10	10	22,0	21,0	19	19	34,0
2700TR121210	G1/2"	12/10	12	22,5	21,0	24	19	34,0

2710

Diritto maschio conico BSPT

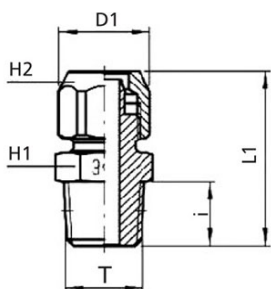

CODE	T	ØD	I	L1	D1	H1	H2	GR.
2710TR1864	R1/8"	6/4	7,5	26,0	13,0	12	12	14,0
2710TR1464	R1/4"	6/4	11,0	30,0	13,0	14	12	21,0
2710TR1886	R1/8"	8/6	7,5	26,0	15,5	12	14	17,0
2710TR1486	R1/4"	8/6	11,0	30,0	15,5	14	14	24,0
2710TR18108	R1/8"	10/8	7,5	27,5	18,5	14	17	28,0
2710TR14108	R1/4"	10/8	11,0	31,5	18,5	14	17	30,0
2710TR38108	R3/8"	10/8	11,5	32,0	18,5	17	17	40,0
2710TR381210	R3/8"	12/10	11,5	33,5	21,0	17	19	34,0
2710TR121210	R1/2"	12/10	14,0	36,5	21,0	22	19	34,0



2720

Gomito maschio conico BSPT

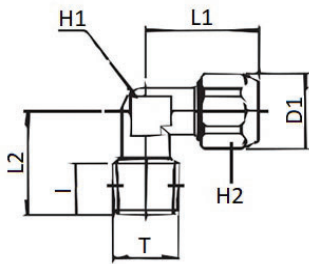

CODE	T	ØD	I	L1	L2	D1	H1	H2	GR.
2720TR1864	R1/8"	6/4	9,0	22,5	18,5	13	10	12	19,0
2720TR1464	R1/4"	6/4	10,5	22,5	21,0	13	10	12	22,0
2720TR1886	R1/8"	8/6	9,0	22,5	18,5	15,5	10	14	20,0
2720TR1486	R1/4"	8/6	10,5	22,5	21,0	15,5	10	14	23,0
2720TR3886	R3/8"	8/6	11,0	26,5	24,5	15,5	13	14	40,0
2720TR18108	R1/8"	10/8	9,0	24,5	18,5	18,5	10	17	26,0
2720TR14108	R1/4"	10/8	10,5	24,5	21,0	18,5	10	17	28,0
2720TR38108	R3/8"	10/8	11,0	27,0	24,5	18,5	13	17	20,0
2720TR381210	R3/8"	12/10	11,5	29,0	25,0	21	13	19	40,0
2720TR121210	R1/2"	12/10	14,0	30,5	29,0	21	17	19	40,0

2725

Gomito maschio girevole conico BSPT

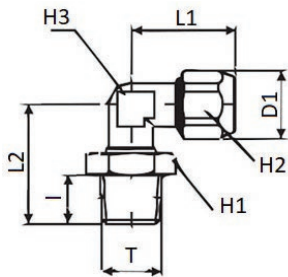

CODE	T	ØD	I	L1	L2	D1	H1	H2	H3	GR.
2725TR1864	R1/8"	6/4	7,5	22,5	21,5	13,0	13	12	10	24,0
2725TR1464	R1/4"	6/4	11,0	22,5	25,5	13,0	17	12	10	28,0
2725TR1886	R1/8"	8/6	7,5	22,5	21,5	15,0	13	14	10	25,0
2725TR1486	R1/4"	8/6	11,0	22,5	25,5	15,0	17	14	10	30,0
2725TR14108	R1/4"	10/8	11,0	24,0	25,5	18,5	17	17	10	36,0

2730

Gomito maschio girevole cilindrico BSPP

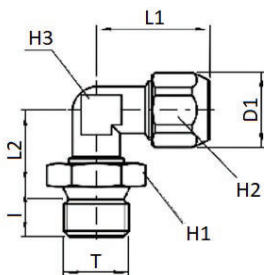

CODE	T	ØD	I	L1	L2	D1	H1	H2	H3	GR.
2730TR1864	G1/8"	6/4	8	22,5	14,0	13,0	13	12	10	24,0
2730TR1464	G1/4"	6/4	10	22,5	14,5	13,0	17	12	10	24,0
2730TR1886	G1/8"	8/6	8	22,5	14,0	15,5	13	14	10	25,0
2730TR1486	G1/4"	8/6	10	22,5	14,5	15,5	17	14	10	29,0
2730TR14108	G1/4"	10/8	10	24,0	14,5	18,5	17	17	10	35,0

2740

T maschio conico BSPT

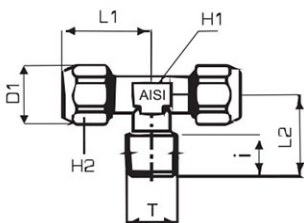

CODE	T	ØD	I	L1	L2	D1	H1	H2	GR.
2740TR1864	R1/8"	6/4	9	22,5	18,5	13,0	10	12	36,0
2740TR1464	R1/4"	6/4	10,5	22,5	21,0	13,0	10	12	44,0
2740TR1886	R1/8"	8/6	9	22,5	18,5	15,5	10	14	31,0
2740TR1486	R1/4"	8/6	10,5	22,5	21,0	15,5	10	14	36,0
2740TR18108	R1/8"	10/8	9	25,0	18,5	18,5	10	17	36,0
2740TR14108	R1/4"	10/8	10,5	25,0	21,0	18,5	10	17	74,0
2740TR38108	R3/8"	10/8	11,5	27,0	25,0	18,5	13	17	70,0
2740TR381210	R3/8"	12/10	11,5	29,0	25,0	21,0	13	19	74,0
2740TR121210	R1/2"	12/10	14,0	30,5	29,0	21,0	17	19	74,0



2745

T maschio girevole conico BSPT

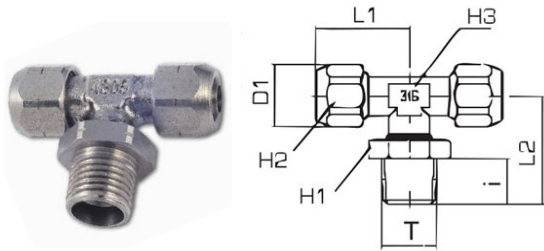

CODE	T	ØD	I	L1	L2	D1	H1	H2	H3	GR.
2745TR1864	R1/8"	6/4	7,5	22,5	21,5	13,0	13	12	10	35,0
2745TR1464	R1/4"	6/4	11,0	22,5	25,5	13,0	17	12	10	39,0
2745TR1886	R1/8"	8/6	7,5	22,5	21,5	15,0	13	14	10	38,0
2745TR1486	R1/4"	8/6	11,0	22,5	25,5	15,0	17	14	10	42,0
2745TR14108	R1/4"	10/8	11,0	24,0	25,5	18,5	17	17	10	40,0

2750

T maschio girevole cilindrico BSPP

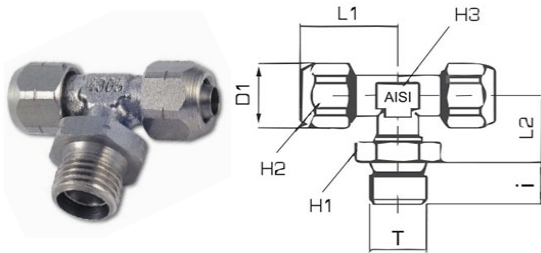

CODE	T	ØD	I	L1	L2	D1	H1	H2	H3	GR.
2750TR1864	G1/8"	6/4	8	22,5	14,0	13,0	13	12	10	36,0
2750TR1464	G1/4"	6/4	10	22,5	14,5	13,0	17	12	10	38,0
2750TR1886	G1/8"	8/6	8	22,5	14,0	15,0	13	14	10	37,0
2750TR1486	G1/4"	8/6	10	22,5	14,5	15,0	17	14	10	41,0
2750TR14108	G1/4"	10/8	10	24,0	14,5	18,5	17	17	10	54,0

2760

T laterale maschio conico BSPT

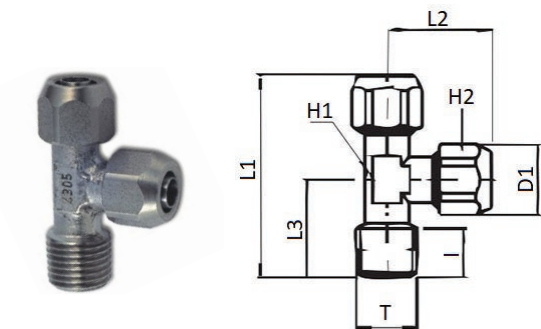

CODE	T	ØD	I	L1	L2	L3	D1	H1	H2	GR.
2760TR1864	R1/8"	6/4	9,0	41,0	22,5	18,5	13,0	10	12	35,0
2760TR1464	R1/4"	6/4	10,5	43,5	22,5	21,0	13,0	10	12	40,0
2760TR1886	R1/8"	8/6	9,0	41,0	22,5	18,5	15,0	10	14	35,0
2760TR1486	R1/4"	8/6	10,5	43,5	22,5	21,0	15,0	10	14	35,0
2760TR18108	R1/8"	10/8	9,0	43,5	25,0	18,5	18,5	10	17	35,0
2760TR14108	R1/4"	10/8	10,5	46,0	25,0	21,0	18,5	10	17	40,0
2760TR38108	R3/8"	10/8	11,5	52,0	27,0	25,0	18,5	13	17	70,0

2770

Intermedio a gomito

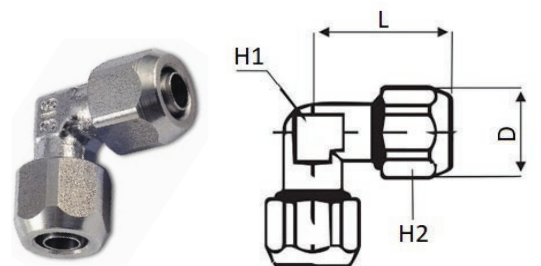

CODE	ØD	L	D1	H1	H2	GR.
2770TR64	6/4	22,5	13,0	10	12	29,0
2770TR86	8/6	22,5	13,5	10	14	29,0
2770TR108	10/8	25,0	15,5	10	17	70,0
2770TR1210	12/10	29,0	21,0	13	19	40,0



2780

Intermedio a T

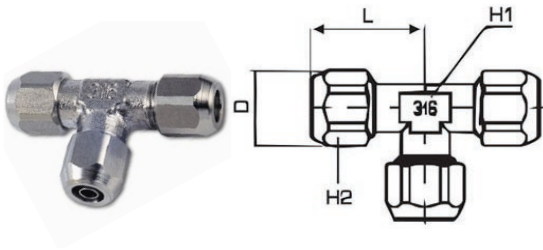

CODE	ØD-A	ØD-B	L	D1	H1	H2	GR.
2780TR64	6/4	6/4	22,5	13,0	10	12	37,0
2780TR86	8/6	8/6	22,5	15,6	10	14	39,0
2780TR108	10/8	10/8	25,0	18,5	10	17	61,0
2780TR1210	12/10	12/10	29,0	21,0	13	19	115,0

2790

Dado di bloccaggio

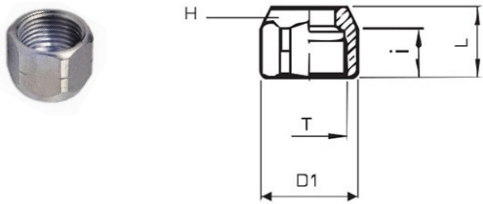

CODE	T	ØD	L	I	D1	H	GR.
2790TRM10164	M10X1	6/4	11,5	8,0	13,1	12	5,0
2790TRM12186	M12X1	8/6	11,5	8,0	15,3	14	6,0
2790TRM141108	M14X1	10/8	13,5	9,5	18,5	17	13,0
2790TRM1611210	M16X1	12/10	14,5	9,0	21,0	19	15,0

2612

Rondella in PVC

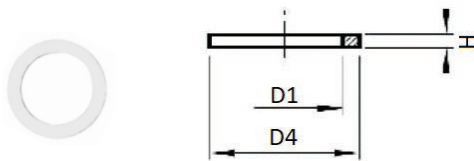

CODE	THREAD	D4	D1	H	GR.
2612TR18	G1/8"	14,0	10,0	1,5	18,0
2612TR14	G1/4"	17,5	13,5	1,5	18,0
2612TR38	G3/8"	21,0	16,7	1,5	18,0
2612TR12	G1/2"	26,0	21,3	1,5	18,0

