

1. General

1.1 Use

The flow meter is used as a flow meter for calculators for heating or cooling consumption measurement in systems with water.













The flow meter consists of a metal measuring part and an associated electronic unit. These two components are affixed with each other by cable.

1.2 General Notes

The flow meter left the factory in a faultless condition where safety is concerned. The manufacturer will provide additional technical support on request. Calibration relevant security seal on the flow meter must not be damaged or removed. Otherwise the guarantee and calibration validity of the flow meter will lapse.

- Keep the packaging so that you can transport the flow meter in its original packaging following expiry of the calibration validity.
- Lay all cables at a minimum distance of 500 mm to high voltage and high frequency cables.
- A relative humidity of < 93 % at 25 °C is permissible (without condensation).
- Avoid cavitation in the whole system due to overpressure i.e. at least 1 bar at qp and approx. 3 bar at qs (applies for approx. 80 °C).

2. Safety Information

-  The flow meter may only be used in building service engineering systems and only for the applications described.
-  The local regulations (installation etc.) must be adhered to.
-  Adhere to the operating conditions according to the dial plate during use. Non-adherence can cause hazards and the guarantee will lapse.
-  The flow meter is only suitable for circulating water in heating systems.
-  The flow meter is not suitable for drinking water.
-  Adhere to the AGFW requirements regarding circulating water (FW510).
-  Do not lift the flow meter by the electronic unit.
-  Be aware of sharp points on the thread, flange and measuring tube.
-  Only personnel, trained in the installation and operation of meters in heating and cooling systems, may install and remove the flow meter.
-  Only install or remove the flow meter when the pipes are pressure-less.
-  After installing the flow meter, check the leak-tightness of the system.
-  Guarantee and calibration validity will lapse if the calibration relevant security seals are broken.



Only clean the flow meter from outside with a soft, lightly wetted cloth. Do not use any spirit or cleaning solvent.



As far as disposal is concerned, the flow meter is a waste electronic appliance in the sense of European Directive 2002/96/EC (WEEE) and it must not be disposed of as domestic waste. The relevant national, legal regulations must be observed as the appliance must be disposed of via the channels provided for this purpose. The local and currently valid legislation must be observed.



The meter contains lithium batteries. Do not dispose of the meter and the batteries with domestic waste. Observe the local stipulations and laws on disposal.



You can return the lithium batteries to the manufacturer for appropriate disposal following use. When shipping please observe legal regulations, in particular, those governing the labelling and packaging of hazardous goods.



Do not open the batteries. Do not bring batteries into contact with water or expose to temperatures above 80 °C.



The flow meter does not have any lightning protection. Ensure lightning protection via the in-house installation.

3. Installation

Proceed as follows to install the flow meter:

- Observe the dimensions of the flow meter and check whether there is sufficient space available.
- Rinse the system thoroughly before installing the flow meter.
- Fit the flow meter vertically or horizontally between two slide valves so that the arrow on the housing and the flow direction match. Also observe the installation situations and the following examples of installation (see figure 2 and figure 3).
- Seal the fittings to protect against manipulation.
- Loosen the elastic band or the cable tie, provided for the transport, from the volume measurement unit. In operation, the control cable should not depend directly on the volume measurement unit.
- If you install the flow meter for cold metering, follow the appropriate notes.

Recommendation: If you are installing more flow meters in one unit, make sure that all the flow meters operate under the same mounting conditions.

Installation Notes



Note: When installing the flow meter the locally applicable installation regulation for flow meters must be observed.

Inlet or outlet sections are not necessary. If you install the flow meter in the common return of two circuits, determine a place of installation with a minimum distance of 10 × DN from the T-piece. This distance ensures a good thorough mixing of the different water temperatures.

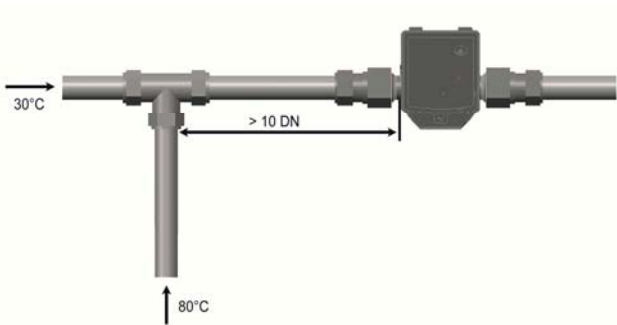

Fig. 1: Mixture of different return temperatures

Examples of installation

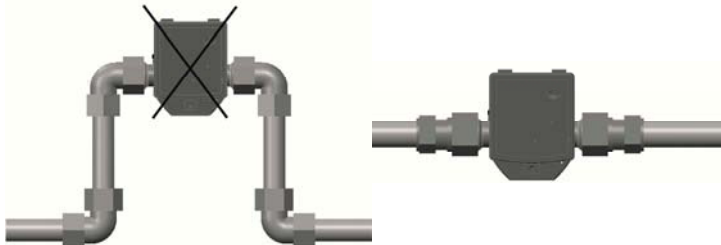

Fig. 2: Avoid accumulation of air

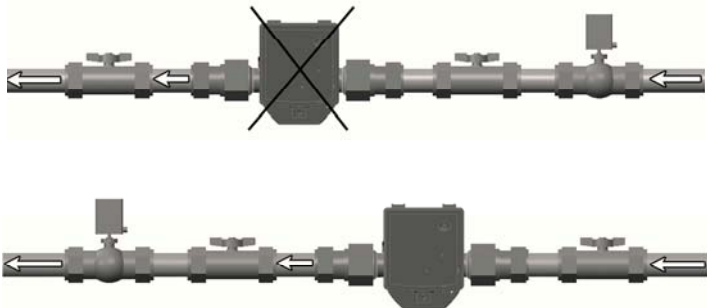

Fig. 3: Mount a valve or a regulator after the flow meter

Note: During installation it must be ensured that no water can enter the electronic unit during operation.

3.1 Installation for cooling metering

Note: It is recommended that the flow meter installed on the hot side.

When installing as a cold meter it is essential that the black cover on the measuring tube is pointed to the side or downwards in order to avoid problems with condensation forming.

Fit the electronic unit separate to the volume measurement tube, e.g. on the wall. Make a loop downwards in order to prevent condensation running along the connected lines into the electronic unit.

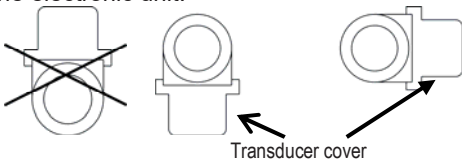

Fig. 4: Recommended installation position for cooling metering

3.2 Installation of qp 150

Note: Use flange bolts with a length of at least 100 mm to install the flanged body in the pipeline.

As an assembly aid two M10 threads are mounted on the flange. The threads allow the use of stainless steel eye bolts, for example, for a lifting device.

The measurement insert in the flanged body should be positioned on the top. This allows a simple exchange of the measurement insert (see chapter 5).

3.3 Electronic unit

The ambient temperature of the electronic unit must not exceed 55 °C. Avoid direct sunlight. For water temperatures between 10 °C and 90 °C you can fit the electronic unit on the volume measurement unit or on the wall.

Aligning electronic unit

Proceed as follows to align the electronic unit:

1. Pull the electronic unit off the volume measurement unit.
2. Turn the electronic unit to the left or right through 90° or 180° as required.
3. Push the electronic unit onto the adapter plate in this position until it engages.

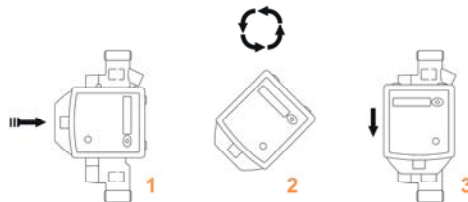

Fig. 5: Electronic unit installation position

Wall fitting (split fitting)

Fit the electronic unit to the wall at water temperatures below 10 °C and above 90 °C.

For wall mounting proceed as follows:

- Pull the electronic unit off the adapter plate.
- Unscrew the adapter plate from the volume measurement unit.
- Fit the adapter plate to the wall.
- Push the electronic unit onto the adapter plate.

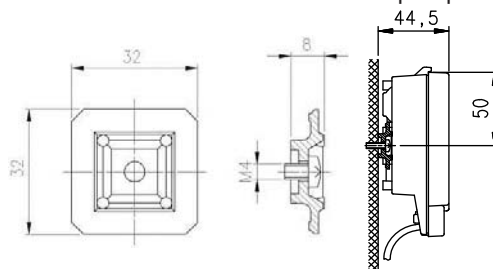

Fig. 6: Adapter plate and wall fitting

3.4 Power supply

The flow meter is equipped with a long life battery for 5 or 9 years of operation. You can take the operating time from the dial plate.



Warning: Do not open the batteries. Do not bring battery into contact with water or expose to temperatures above 80 °C. Dispose of used batteries at suitable collection points.



Note: Only batteries approved by the manufacturer may be installed.

3.5 Interfaces

The flow meter is equipped with an optical interface in accordance with EN 62056-21 as standard.

In addition, the flow meter is equipped with a pulse output and is delivered with a 2m two wire cable. The connecting cable can be lengthened with a cable 2 x 0.75mm². A distributing box is recommended.

4. Getting Started

For activation proceed as follows:

- Open the slide valves slowly.
- Check the system for leak-tightness and bleed air out carefully.

After more than 100 sec. the flow meter begins to work.

If the operating limit is exceeded and the flow rate is positive, volume pulses are generated according to the pulse parameter settings.

- Check the measured value flow or the volume of progress on the connected calculator for plausibility.
- Vent the system until the flow rate value on the calculator is stable. Check the output.
- Fit the user locks to the fittings.

5. Functional Details

The operating hours are counted from the first connection of the power supply.

Missing hours are summated if there is an error and the flow meter is thus unable to take a measurement.

Operating hours and missing hours can be reset through the service software.



Note: Detailed information's on resetting operating hours and missing hours with the service software you will find in the UltraAssist user manual.

Volume readings, maximum flow rates and missing hours are stored monthly for 36 months.

The device number and the firmware version number are issued by the manufacturer.

6. Technical Data



Note: The information on the flow meter must be observed!

General

Measuring accuracy	Class 2 or 3 (EN 1434)
Environment class	A (EN 1434) for indoor installation
Mechanical class	M1 *)
Electromagnetic class	E1 *)
*) according to 2004/22/EC Directive on Measuring Instruments	
Ambient humidity	< 93 % rel. humidity at 25 °C, without condensation
Max. height	2000 m above sea level
Storage temperature	- 20 ... 60 °C

Electronic unit

Ambient temperature	5 ... 55 °C
Housing protection rating	IP 54 according to EN 60529
Power supply	Battery for 5 or 9 years
Optical interface	Standard, EN 62056-21
Communication	Pulse output
Separability	Always, optional cable length

Pulse output

Type	Open drain
Dielectric strength	500 V _{eff} against ground, galvanic insulated
Pulse significance	Optional
Pulse length	Optional
Pulse sequence	In packages every 0,5 s (not equally spaced)
Cable length	2 m
Voltage	Maximal 30 V
Current	Maximal 30 mA
Voltage drop	< 0,3 V at 10 mA
Polarity	bipolar

Volume measurement unit

Protection class	IP 54 / IP 65 according to EN 60529 IP 68 (at qp 150) according to EN 60529
Mounting place	Hot side / cold side
Installation position	Any
Flow straightening	None
Measuring range	1:100 resp. 1:50
Temperature range	5 ... 130 °C National type approvals may be different.
recommended...	
...heat application	10 ... 130 °C
...cooling application	5 ... 50 °C
Maximum temperature	150 °C for 2000 h
Maximum overload	2,8 x qp
Nominal pressure	PN16 (1,6 MPa; PS16), PN25 (PS25)

7. EU-Directives Declaration of Conformity

Landis+Gyr GmbH, Humboldtstr. 64, D-90459 Nürnberg, Germany hereby declares that the type Ultraheat T150 / 2WR7 meter meets the requirements of the following directives:

- **2004/108/EC** Electromagnetic Compatibility of Electronical and Electronic Devices
- **2006/95/EC** Low voltage directive
- **2004/22/EC** Measuring instruments directive
- **2011/65/EU** Directive on the Restriction of the Use of Certain Hazardous Substances in Electrical and Electronic Equipment (RoHS2)
- **1997/23/EC** Pressure Equipment Directive

Nürnberg, 17.03.2014

Brunner, COO Fuchs, Head R&D

name, function

signature

name, function

signature

This declaration and the associated documents are deposited with Mr. Fuchs c/o Landis+Gyr with the number CE 2WR7 007/03.14.

EC type-examination certificate
DE-06-MI004-PTB004

Certificate recognising the quality management system
DE-12-AQ-PTB006MID

Notified body:
PTB Braunschweig and Berlin, Germany; identification number
0102